

RT36 Enclosed Tube Type Fuse

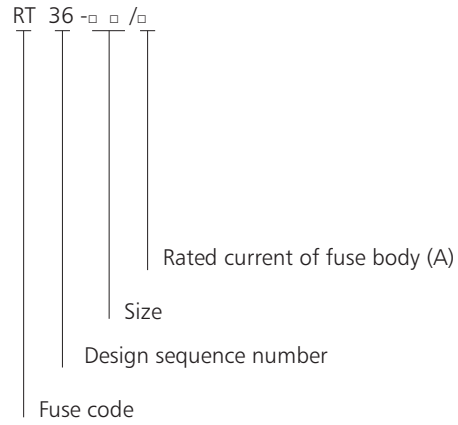

1. General

- 1.1 Electric ratings: AC690V, up to 1000A;
- 1.2 Application: For protection of electric apparatus against over-load and short circuit;
- 1.3 Features: Compact design, light weight, low power consumption and high breaking capacity;
- 1.4 Standard: IEC 60269.







2. Type Designation



3. Technical Data

Specifications	Rated current (A)	Rated voltage (V)	Rated power (W)	Weight (kg)	Breaking capacity (kA)
 RT36-00C, NT00C, R030A (Base: RT36-00)	4	500	1.5	0.12	120
	6	500	1.6	0.12	120
	10	500	1.7	0.12	120
	16	500	2.0	0.12	120
	20	500	2.5	0.12	120
	25	500	3.1	0.12	120
	32	500	3.5	0.12	120
	36	500	3.8	0.12	120
	40	500	4.0	0.12	120
	50	500	5.3	0.12	120
	63	500	6.1	0.12	120
 RT36-00, RT16-00(NT00)	80	500	6.9	0.12	120
	100	500	10.0	0.12	120
	4	500/690	1.5	0.15	120/50
	6	500/690	1.6	0.15	120/50
	10	500/690	1.7	0.15	120/50
	16	500/690	2.0	0.15	120/50
	20	500/690	2.5	0.15	120/50
	25	500/690	3.1	0.15	120/50
	32	500/690	3.5	0.15	120/50
	36	500/690	3.8	0.15	120/50
	40	500/690	4.0	0.15	120/50

Fuses

Specifications	Rated current (A)	Rated voltage (V)	Rated power (W)	Weight (kg)	Breaking capacity (kA)
 RT36-00, RT16-00(NT00)	50	500/690	5.3	0.15	120/50
	63	500/690	6.1	0.15	120/50
	80	500/690	6.9	0.15	120/50
	100	500/690	10.0	0.15	120/50
	125	500/690	9.6	0.15	120/50
	160	500/690	12.0	0.15	120/50
 RT36-0, RT16-0(NT0)	4	500/690	1.7	0.2	120/50
	6	500/690	2.0	0.2	120/50
	10	500/690	1.8	0.2	120/50
	20	500/690	3.0	0.2	120/50
	25	500/690	3.5	0.2	120/50
	32	500/690	4.05	0.2	120/50
	36	500/690	4.0	0.2	120/50
	40	500/690	5.1	0.2	120/50
	50	500/690	7.25	0.2	120/50
	63	500/690	8.1	0.2	120/50
	80	500/600	10.26	0.2	120/50
	100	500/690	12.58	0.2	120/50
	125	500/690	15.62	0.2	120/50
160	500/690	16.0	0.2	120/50	
 RT36-1, RT16-1(NT1)	80	500/690	8.35	0.36	120/50
	100	500/690	12.05	0.36	120/50
	125	500/690	13.46	0.36	120/50
	160	500/690	16.53	0.36	120/50
	200	500/690	20.8	0.36	120/50
	224	500/690	22.69	0.36	120/50
 RT36-2, RT16-2(NT2)	250	500/690	23.0	0.36	120/50
	125	500/690	21.7	0.85	120/50
	160	500/690	22.7	0.85	120/50
	200	500/690	26.8	0.85	120/50
	224	500/690	28.9	0.85	120/50
	250	500/690	28.9	0.85	120/50
	300	500/690	32.0	0.85	120/50
	315	500/690	32.45	0.85	120/50
	355	500/690	33.66	0.85	120/50
	400	500/690	34.0	0.85	120/50
 RT36-3, RT16-3(NT3)	315	500/690	34.45	0.85	120/50
	355	500/690	35.96	0.85	120/50
	400	500/690	38.09	0.85	120/50
	425	500/690	40.20	0.85	120/50
	500	500/690	45.23	0.85	120/50
 RT36-4, RT16-4(NT4)	630	500/690	48.0	0.85	120/50
	800	500/690	75.08	1.95	120
 NRT36-00, NH00	1000	500/690	90.0	1.95	120
	160	500/690	12	0.15	120/50

4. Overall and Mounting Dimensions

4.1 Dimension of fuse body

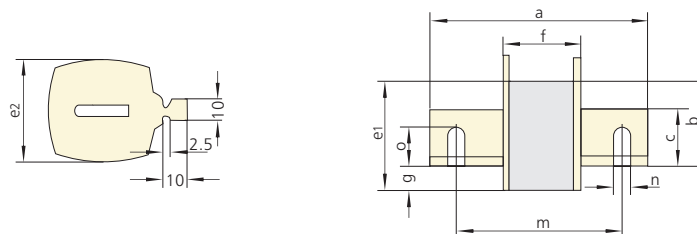

Dimension	RT36-00C	RT36-00	RT36-0	RT36-1	RT36-2	RT36-3	RT36-4	NRT36-00
a	78.5	78.5	125	135	150	150	200	78.5
b	35	35	35	40	48	60	83	35
c	15	15	15	21	27	33	50	15
e1	45	45	45	48	58	67	96	45
e2	20	29	29	48	58	67	88	29
f	49	49	68	68	68	68	79	49
g	10	10	11.5	12	13	14	20	11.5
m	-	-	-	-	-	-	150	-
n	-	-	-	-	-	-	16	-
o	-	-	-	-	-	-	32	-

4.2 Dimension of fuse holder

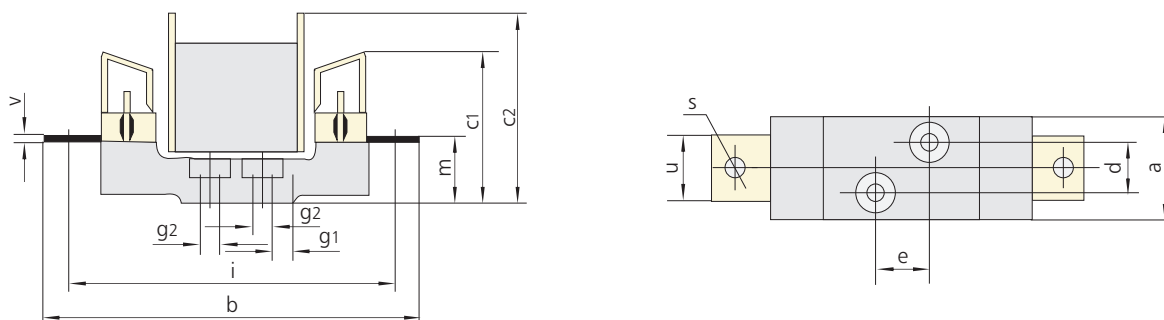

Dimension	RT36-00	RT36-0	RT36-1	RT36-2	RT36-3	RT36-4	NRT36-00
a	30	33	58	64	64	96	30
b	118	170	200	225	250	304	120
c1	60	73	82	98	105	145	60
c2	85	93	96	112	120	165	85
d	0	0	30	30	30	45	0
e	25	25	25	25	25	30	25
g1	8	16	15	17	17	4	8
g2	8.3	7.5	10.5	10.5	10.5	13	7.5
i	100	150	175	200	210	260	100
m	25	38	38	40	45	47.5	25
s	M8	M8	M10	M10	M12	M16	M8
u	25	25	25	30	40	45	25